

# KR3000 SERIES GRAPHIC RECORDER



KR3000 Series are network-compatible paperless recorders with high performance and high operating function employed high visibility 12.1" TFT color LCD display and touch panel operation system. High speed of sampling rate 100ms for 48 points and high accuracy of  $\pm 0.1\%$  were realized, and measured data is stored into internal memory and maximum 2GB compact flash card (CF card).

As it can be monitored by a web browser display on several computers on intranet or internet, FTP transfer of data file and E-mail notification are also available.



## ■ FEATURES

### ● Large sized 12.1" TFT color LCD display

- Large-sized high visibility display with various display functions. Real time/Historical trend screen, Bar-graph screen, Data screen are selectable for various applications.
- Combination display for selected 4 screens is available. It is easy to switch to individual screen by touching panel.

### ● Large capacity of data memory and various recording method

- Compact flash card (CF card) slot is equipped as standard external memory. Large capacity storage of maximum 2GB is available.
- Various data storing methods are selectable such as schedule programming by time of day and time of date, recording start-up by external signal and event, and data logging of before and after trigger points for alarm.

### ● Multi points recording with high speed/high accuracy

- High-speed recording of approximately 100ms for 48 points and high accuracy of  $\pm 0.1\%$  were realized. Stable measuring and recording are possible with high speed.
- High withstand voltage of 1000V AC between input channels.

### ● Easy operating and programming without manuals

- Easy operating by dedicated keys for each function and touch panel.
- USB port is prepared in front compartment. Setting file and data file are stored in USB memory stick.

### ● LAN network capability

- Various networked environment such as remote monitoring by browser, FTP server, FTP client and E-mail notification are applied as Ethernet is equipped as standard.

### ● Analyzing/data acquisition application software

- It is easy to replay and edit the recorded data file. Replay display has functions of vertical/horizontal trend, circular trend, and also wave-analyzing and marking by using the cursor.

## ■ MODELS

- KR31 - A
- Measuring points/sampling rate
    - 20: 12 points/100ms
    - 40: 24 points/100ms
    - 60: 36 points/100ms
    - 80: 48 points/100ms
    - 21: 12 points/1s
    - 41: 24 points/1s
    - 61: 36 points/1s
    - 81: 48 points/1s
  - Communications interface (option)
    - N: None
    - R: High-order (RS232C)
    - S: High-order (RS422A/RS485)
  - Digital input/alarm output (option)
    - 0: None
    - 1: Alarm output 12 points (a contact)
    - 2: Alarm output 6 points (c contact)
    - 3: Alarm output 24 points (a contact)
    - 4: Alarm output 12 points (c contact)
    - 5: Alarm output 12 points (a contact) + 6 points (c contact)
    - A: Digital input 8 points
    - B: Digital input 8 points + alarm output 12 points (a contact)
    - C: Digital input 8 points + alarm output 6 points (c contact)
    - D: Digital input 8 points + alarm output 24 points (a contact)
    - E: Digital input 8 points + alarm output 12 points (c contact)
    - F: Digital input 8 points + alarm output 12 points (a contact) + alarm output 6 points (c contact)

## ■ SCREENS

### ● Real-time trend screen

Displays data (measured and virtual) of selected group. Vertical trend and horizontal trend selectable.

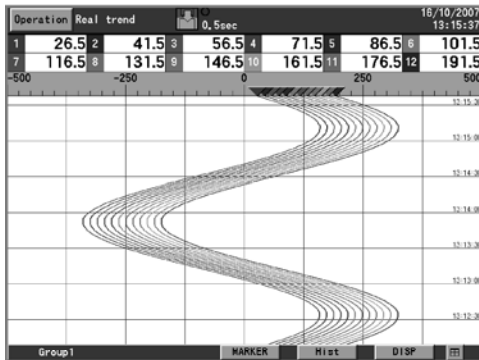

### ● Bar-graph screen

Displays data (measured and virtual) of selected group. Combination display with real-time trend is available.

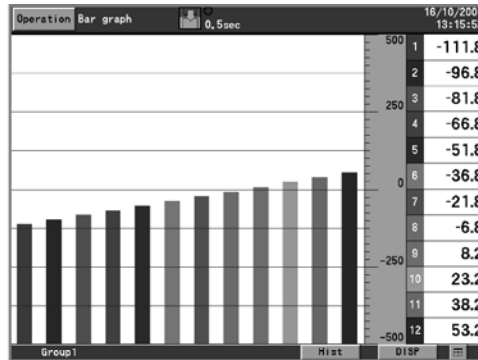

### ● Data screen

Displays data (measured and virtual) of selected group. Simultaneous display of alarm status.

TIC-001	TIC-002	TIC-003	TIC-004	CH5	CH6	CH7	CH8	CH9	CH10	CH11	CH12
-194.5	-179.5	-164.5	-149.5	-134.5	-119.5	-104.5	-89.5	-74.5	-59.5	-44.5	-29.5
MAX: 190.0 MIN: -340.0	MAX: 175.0 MIN: -325.0	MAX: 190.0 MIN: -310.0	MAX: 205.0 MIN: -295.0	MAX: 220.0 MIN: -280.0	MAX: 235.0 MIN: -265.0	MAX: 250.0 MIN: -250.0	MAX: 265.0 MIN: -235.0	MAX: 280.0 MIN: -220.0	MAX: 295.0 MIN: -205.0	MAX: 310.0 MIN: -190.0	MAX: 325.0 MIN: -175.0

### ● 4 separate screen

Switchable from displayed 4 screens to individual screen by touch panel.

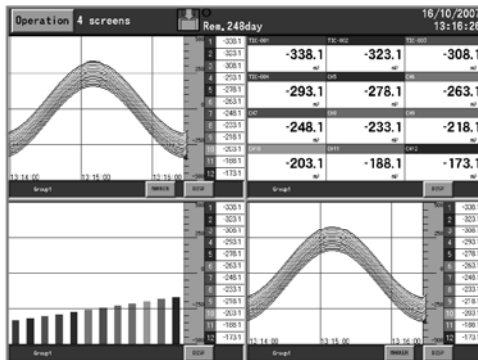

### ● Information screen

Start date and time	End date and time	Data count
16/10/2007 12:55:53	16/10/2007 13:07:48	1431
16/10/2007 12:53:50	16/10/2007 12:54:50	122
16/10/2007 12:53:20	16/10/2007 12:53:44	124
10/10/2007 18:30:05	10/10/2007 18:30:49	444
10/10/2007 11:30:47	10/10/2007 11:30:49	11
28/09/2007 17:28:27	28/09/2007 17:29:32	329
28/09/2007 17:01:36	28/09/2007 17:02:19	218
28/09/2007 17:01:36	28/09/2007 17:02:27	259
28/09/2007 18:55:42	28/09/2007 18:56:14	161
28/09/2007 18:55:42	28/09/2007 18:56:32	254
28/09/2007 18:55:00	28/09/2007 18:55:27	140
28/09/2007 11:08:06	28/09/2007 11:08:24	92
28/09/2007 11:07:09	28/09/2007 11:07:44	178
28/09/2007 10:52:38	28/09/2007 11:06:06	4041
28/09/2007 10:52:38	28/09/2007 11:04:38	3601
28/09/2007 10:52:38	28/09/2007 11:03:38	3301

### ● HOME setting screen

Channel parameter :ALL channels batch

Range type: K

Range: -200 to 1370

Scale: -200 to 1370

RJ: Internal

Burn out: NONE

Recording cycle: 1 sec.

Specifications

Return

### ● Channel setting screen

CH.	Range type	Tag	Unit
1	K	TIC-001	°C
2	K	TIC-002	°C
3	T	TIC-003	°C
4	T	TIC-004	°C
5	200mV		mV
6	2V		V
7	5V		V
8	10V		V
9	20V		V
10	Pt100		°C
11	JPt100		°C
12	200mV		mV
13	----		mV

Return

### ● Schedule setting screen

Schedule settings Date

Date settings

Start date and time: 01/01/07 00:00

End date and time: 02/01/07 00:00

Day setting: Sun Mon Tue Wed Thu Fri Sat

Usage days: [ ] [ ] [ ] [ ] [ ] [ ] [ ]

Start time: 00:00

End time: 00:00

Return

## INPUT SPECIFICATIONS

Measuring points: 12 points, 24 points, 36 points and 48 points  
 Input types: Universal  
 DC voltage ---  $\pm 13.8\text{mV}$ ,  $\pm 27.6\text{mV}$ ,  $\pm 69.0\text{mV}$   
 $\pm 200\text{mV}$ ,  $\pm 500\text{mV}$ ,  $\pm 2\text{V}$   
 $\pm 5\text{V}^*$ ,  $\pm 10\text{V}^*$ ,  $\pm 20\text{V}^*$ ,  $\pm 50\text{V}^*$   
 (\*with built-in voltage divider)  
 DC current --- With external shunt resistor (sold separately)  
 Thermocouple --- B, R, S, K, E, J, T, N, PtRh40-PtRh20,  
 W-WRe26, WRe5-WRe26, Platinel, NiMo-Ni, CR-AuFe, U, L  
 Resistance thermometer --- Pt100, JPt100, Pt50, Pt-Co  
 Refer to the table of measuring range, accuracy ratings and display resolution  
 Accuracy ratings: Refer to the table of measuring range, accuracy ratings and display resolution  
 Reference junction compensation accuracy: K, E, J, T, N, Platinel ---  $\pm 0.5^\circ\text{C}$  or less  
 R, S, W-WRe26, WRe5-WRe26, NiMo-Ni, CR-AuFe, U, L ---  $\pm 1.0^\circ\text{C}$  or less  
 Sampling rate: 100ms --- Approximately 100ms for all points  
 1s --- Approximately 300ms for all points  
 Burnout: Disconnection of input signal is detected on thermocouple and resistance thermometer input. UP/DOWN/DISABLE is selectable for each input  
 Scaling: Range/scale is selectable when DC voltage/current is programmed  
 Digital filter: FIR filter  
 Allowable signal source resistance: Thermocouple input (burnout disable)/  
 DC voltage input ( $\pm 2\text{V}$  or less) ---  $1\text{k}\Omega$  or less  
 DC voltage input ( $\pm 5\text{V}$  or more) ---  $100\Omega$  or less  
 Resistance thermometer --- Per wire  $10\Omega$  or less (same resistance for 3 wires)  
 Input resistance: DC voltage, thermocouple input --- Approximately  $1\text{M}\Omega$   
 Maximum input voltage: DC voltage input ( $\pm 2\text{V}$  or less)/  
 thermocouple input (burnout disable) ---  $\pm 10\text{VDC}$   
 DC voltage input ( $\pm 5\text{V}$  to  $\pm 50\text{V}$ ) ---  $\pm 60\text{VDC}$   
 Dielectric strength between channels: 1000V AC or more between each channel  
 (High strength semiconductor relay used)  
 (B terminal of resistance thermometer is shorted inside between channels.)  
 Common mode rejection ratio: 120dB  
 Series mode rejection ratio: 50dB

## RECORDING SPECIFICATIONS

Memory for history: 136MB  
 Additional memory: CF card (Up to 2GB)  
 Recording cycle: 100, 200, 500ms  
 1, 2, 3, 5, 10, 15, 20, 30s  
 1, 2, 3, 5, 10, 15, 20, 30, 60min  
 Logging data: Measured data --- File name (group name), time of day, month and year of recording start, tag, measured data, alarm status/types, makertext  
 Setting parameter  
 Binary/CSV type  
 Manual start/stop (dedicated key operation)  
 Schedule (designation for time of day and date)  
 Trigger signal (alarm event, digital input)  
 Data logging of before and after trigger points  
 \* Pre-trigger is selectable  
 Measuring numbers of pre-trigger --- Max 950 data  
 6 groups of 56 points/group can be programmed (Up to Total of 128 points)  
 Recording group: Measuring numbers of pre-trigger --- Max 950 data  
 6 groups of 56 points/group can be programmed (Up to Total of 128 points)

When 12 channels recorded in sampling mode (real data).

Recording cycle	128MB	256MB	512MB	1GB	2GB
0.1 sec	3.16 days	6.32 days	12.6 days	25.3 days	50.6 days
1sec	31.6 days	63.2 days	126 days	253 days	1.4 yrs
60 sec	5.2 yrs	10 yrs	21 yrs	42 yrs	83 yrs

When 24 channels recorded in sampling mode (real data).

Recording cycle	128MB	256MB	512MB	1GB	2GB
0.1 sec	1.58 days	3.16 days	6.32 days	12.6 days	25.3 days
1sec	15.8 days	31.6 days	63.2 days	126 days	253 yrs
60 sec	2.6 yrs	5.2 yrs	10 yrs	21 yrs	42 yrs

When 36 channels recorded in sampling mode (real data).

Recording cycle	128MB	256MB	512MB	1GB	2GB
0.1 sec	1.05 days	2.11 days	4.20 days	8.43 days	16.9 days
1sec	10.5 days	21.1 days	42.0 days	84.3 days	168 days
60 sec	1.7 yrs	3.3 yrs	7 yrs	14 yrs	27 yrs

When 48 channels recorded in sampling mode (real data).

Recording cycle	128MB	256MB	512MB	1GB	2GB
0.1 sec	18.9 days	1.58 days	3.16 days	6.32 days	12.6 days
1sec	7.9 days	15.8 days	31.6 days	63.2 days	126 yrs
60 sec	1.3 yrs	2.6 yrs	5.2 yrs	10 yrs	21 yrs

## COMPUTATION SPECIFICATIONS

Computation points: Maximum 128 points  
 Computation cycle: 100ms for all points  
 Computation types: Arithmetic operations --- Addition, subtraction, multiplication, division, remainder, exponential  
 Comparison operations --- Equality, inequality, great, less, equality/great, equality/less  
 Logical operations --- AND, OR, XOR, NOT  
 General functions --- Round-up, round-down, absolute value, square root, exponent of e, natural logarithm, common logarithm  
 Integration operations --- Analog integration, digital integration  
 Channel data operations --- Measured data computation, calculated data computation  
 Others --- Dew point, relative humidity, F-value  
 Remaining amount of CFcard

## ALARM SPECIFICATIONS

Setups: Up to 4 alarms can be programmed per channel  
 Alarm types: Upper limit, lower limit, differential upper limit, differential lower limit (deadband is selectable), abnormal data  
 Delay function: Setup range of alarm delay --- 1 to 3600 seconds  
 Alarm settings: AND/OR selectable  
 Alarm outputs: Refer to option specification

## DISPLAY SPECIFICATIONS

Display: 12.1" TFT color LCD  
 Display types: Measured data display (Trend screen, Data screen, Bar-graph screen)  
 Historical trend display (simultaneous display with Real-time trend is available)  
 Information display (alarm display, marker list, file list)  
 Setting screen (alarm, computation, memory, system, maintenance, communication, etc.)  
 Trend screen: 48 colors selectable  
 Display screen --- 6 screens (6 groups)  
 Display points --- Maximum 56 points/screen  
 Time axis direction --- Vertical or horizontal  
 Line width --- 1 to 5 dot selectable  
 Scale display --- 4 scales  
 Tag/data display --- Show/hide selectable  
 Marker display  
 Data screen: Display screen --- 6 screens (6 groups)  
 Display points --- Maximum 56 points/screen  
 Display contents --- Measured value, channel/tag, unit, alarm status  
 Bargraph screen: 48 colors selectable  
 Display screen --- 6 screens (6 groups)  
 Display points --- Maximum 56 points/screen  
 Display direction --- Vertical or horizontal  
 Scale display --- 1 scale  
 Information display: Alarm display (alarm activation/released history display)  
 Marker list  
 File list (group data file list display)  
 Unit information (Model, serial no., option, etc.)  
 LCD back light: Auto/manual OFF function  
 Brightness --- 4 levels adjustment

\*The LCD display may contain some pixels that always or never illuminate, and the brightness of some areas of the display may appear uneven. There are typical LCD performance characteristics and do not constitute malfunctions.

## COMMUNICATION FUNCTIONS

### Network

Communication type: Ethernet (10BASE-T/100BASE-TX)  
 FTP server : Data file can be read from the network computer  
 FTP client : Transfer a data file to a network server  
 SNMP client : The time can be synchronized to the time of SNMP server  
 Web server : Conformed to HTTP1.0 --- Display the alarm, information of maintenance by browser software (InternetExplorer5.0 or later, NetScape6.0 or later, Opera7 or later)  
 \* User's ID and password registration available.  
 E-Mail: E-Mail notification at specified time for alarm activation  
 Report data at specified time is selectable from all registered data  
 Notification address --- Maximum 8 contacts

### USB Communications

Communication type: USB2.0 (full speed), host function  
 USB memory stick is used as external memory  
 Some USB memory stick can not be used.

## CONNECTIVITY

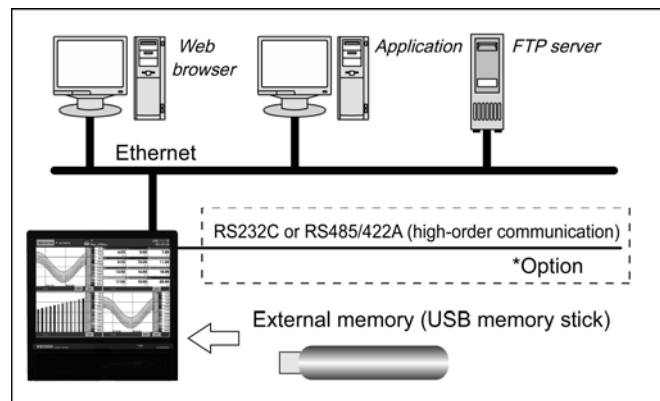

## PROGRAMING/OPERATION

Operation method:	Touch panel/dedicated key
Operation keys:	HOME, MENU, DISP, MARKER, SCROLL, CURSOR, START, STOP, DIRECTION keys, ENTER, ESC
HOME settings:	Simple recording settings --- Common setting to all channels Parameter programming for all channels together, recording cycle, selection settings
MENU settings:	Input/computation programming --- Input parameter, computation parameter DISP Settings --- Data channel parameter, group parameter, common parameter (combination display, trend vertical/horizontal) Alarm settings File settings (6 individual files) --- Storing method settings Marker text settings System settings --- Communication, clock, maintenance, key lock, password, screen, etc.
DISP operations:	Operating screen selection --- Trend, data, bar-graph, historical trend, alarm display, maker list Display selection on each screen --- Group 1 to 6 selectable

## GENERAL SPECIFICATIONS

Rated power voltage:	100 to 240V AC (universal power supply) 50/60Hz
Maximum power consumption:	65VA
Reference operating condition:	Ambient temperature --- 21 to 25°C Ambient humidity --- 45 to 65%RH Power voltage --- 100V AC±1.0% Power frequency --- 50/60Hz±0.5% Attitude --- Left/right 0°, forward/backward 0° Warm-up time --- Longer than 30 minutes
Normal operating condition:	Ambient temperature --- 0 to 50°C Ambient humidity --- 20 to 80%RH Power voltage --- 90 to 264V AC Power frequency --- 50/60Hz±2% Attitude --- left/right 0°, forward tilting 0°, backward tilting 0° to 20°
Transport condition (at the packed condition on shipment from our factory):	Ambient temperature --- -20 to 60 °C Ambient humidity --- 5 to 90%RH (No dew condensation) Vibration --- 10 to 60Hz 4.9m/ S <sup>2</sup> (0.5G) or less Impact --- 392m/S <sup>2</sup> (40G) or less
Storage condition:	Ambient temperature --- -20 to 60°C Ambient humidity --- 5 to 90%RH (No dew condensation)
Power failure protection:	Setups and data are backed up by flash memory. Clock:Lithium battery backs up RAM (Minimum 5 years)
Insulation resistance:	Secondary terminals and protective conductor terminals --- 20MΩ or more at 500V DC Primary terminals and protective conductor terminals --- 20MΩ or more at 500V DC Primary and secondary terminals --- 20MΩ or more at 500V DC Primary terminals: power terminals (L,N), alarm output terminals Secondary terminals: measuring input terminals, digital input terminals, communications terminals
Dielectric strength:	Secondary terminals and protective conductor terminals --- 1 minute at 500V AC Primary terminals and protective conductor terminals --- 1 minute at 1500V AC Primary and secondary terminals --- 1 minute at 2300V AC Primary terminals:power terminals (L,N), alarm output terminals Secondary terminals: measuring input terminals, digital input terminals, communications terminals
Case assembly material:	Front bezel --- ABS resin Case --- Steel
Color:	Front bezel --- Black (equivalent to Mussel N3.0) Case --- Painting color, gray (equivalent to Mussel N7.0)
Weight:	7.2kg
Mounting:	Panel mounting
Terminal screws:	Power terminals/protective conductor terminals/communications terminals --- M4.0 Measuring input terminals/alarm output terminals/digital input terminals --- M3.5

## OPTIONS

Options	Specifications	
Alarm output	Mechanical relay contact output for abnormal input and alarm activation Output: 24 points (a contact), 12 points (a contact, c contact), 6 points (c contact) Contact rating: Mechanical relay --- 100V AC 0.5A, 240V AC 0.2A, 30V DC 0.3A	
Communications interface	High-order communications	Communications interface for high-order units RS232C,RS422A/RS485 (MODBUS) switchable *Ethernet is standard equipped
Digital inputs	ON/OFF signal	ON/OFF input recording
	Pulse input	Maximum 10Hz pulse input Used for flow, operating time and frequency Input system:Photocoupler isolation (Common use for contact and pulse input) Built-in isolated power supply (approx. 5V) Input type: Non-power contact, open collector (TTL or transistor)
	Remote contact	The following operations are available by contact Input 8 points and common signal 4 points (Selectable by parameter). -Data memory triggering Start data recording by conductive signal from OFF to ON Data recording while conductive signal is ON -Marker display Registered makers display by conductive signal from OFF to ON -Integration operations Reset data for integration operations (all channels simultaneously)
Others	Point indication card	

## OPERATION KEYS

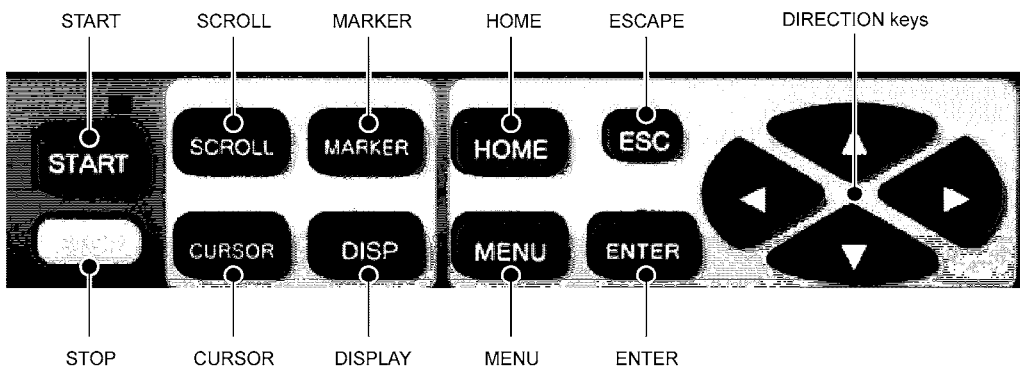

## MEASURING RANGES/ACCURACY RATINGS

Input type	Measuring range	Accuracy rating	
DC voltage	-13.80 to 13.80mV	±0.1%±1digit	
	-27.60 to 27.60mV		
	-69.00 to 69.00mV		
	-200.0 to 200.0mV		
	-500.0 to 500.0mV		
(with built-in voltage divider)	-2.000 to 2.000V	±0.1%±1digit	
	-5.000 to 5.000V		
	-10.00 to 10.00V		
	-20.00 to 20.00V		
	-50.00 to 50.00V		
T/C	K	-200.0 to 300.0°C	±0.1%±1digit *-200 to 0°C: ±0.2%±1digit
		-200.0 to 600.0°C	
		-200 to 1370°C	
	E	-200.0 to 200.0°C	
		-200.0 to 350.0°C	
		-200 to 900°C	
	J	-200.0 to 250.0°C	±0.1%±1digit *0 to 400°C: ±0.2%±1digit
		-200.0 to 500.0°C	
		-200 to 1200°C	
	T	-200.0 to 250.0°C	±0.1%±1digit *0 to 400°C: ±0.2%±1digit
		-200.0 to 400.0°C	
	R	0 to 1200 °C	±0.1%±1digit *0 to 1760 °C: ±0.2%±1digit
		0 to 1760 °C	
	S	0 to 1300°C	±0.1%±1digit *0 to 400°C: Out of accuracy ratings *400 to 800°C: ±0.15%±1digit
		0 to 1760°C	
	B	0 to 1820°C	±0.15%±1digit *-200 to 0°C: ±0.3%±1digit
N	-200.0 to 400.0°C		
	-200.0 to 750.0°C	±0.15%±1digit *0 to 100°C: ±4%±1digit *100 to 400°C: ±0.5%±1digit	
	-200 to 1300°C		
W-WRe26	0 to 2315°C	±0.2%±1digit	
WRe5-WRe26	0 to 2315°C		
PtRh40-PtRh20	0 to 1888°C	±0.2%±1digit *0 to 300°C: ±1.5%±1digit *300 to 800°C: ±0.8%±1digit	
NiMo-Ni	-50.0 to 290.0 °C		
	-50.0 to 600.0 °C	±0.2%±1digit *0 to 20K: ±0.5%±1digit *20 to 50 K: ±0.3%±1digit	
	-50 to 1310 °C		
CR-AuFe	0.0 to 280.0K	±0.15%±1digit	
Platinel	0.0 to 350.0°C		
	0.0 to 650.0°C	±0.15%±1digit	
	0 to 1395°C		
U	-200.0 to 250.0°C	±0.1%±1digit *-200 to 0°C: ±0.3%±1digit	
	-200.0 to 500.0°C		
	-200.0 to 600.0°C		
L	-200.0 to 250.0°C	±0.1%±1digit *-200 to 0°C: ±0.2%±1digit	
	-200.0 to 500.0°C		
	-200 to 900 °C		
RTD	Pt100	-140.0 to 150.0°C	±0.1%±1digit *-140.0 to 150.0°C: 700 to 850°C: ±0.15%±1digit
		-200.0 to 300.0°C	
		-200.0 to 850.0°C	
	JPt100	-140.0 to 150.0°C	±0.1%±1digit *-140.0 to 150.0°C: ±0.15%±1digit
	-200.0 to 300.0°C		
	-200.0 to 649.0°C		
Pt50	-200.0 to 649.0°C	±0.1%±1digit *4 to 50K: ±0.3%±1digit	
Pt-Co	4.0 to 374.0K		

Note: The accuracy ratings are converted into the measuring range under reference operating condition. Thermocouple input does not contain reference junction compensation accuracy.  
 K, E, J, T, R, S, B, N: IEC584, JIS C1602-1995  
 W-WRe26, WRe5-WRe26, PtRh40-PtRh20, Platinel, NiMo-Ni, Cr-AuFe: ASTM Vol14.03  
 U(Cu-CuNi), L(Fe-CuNi): DIN43710  
 Pt100: IEC751(1995), JIS C1604-1997,  
 JPt100: JIS C1606-1989

## APPLICATION SOFTWARE ZAILA (sold separately)

The software is applied for replay display/wave editing operation of recorded data in KR3000 series. It has replay display of vertical/horizontal trend and circular trend function, and also analyzing function such as magnify/reduce/partially magnify of graphs and message insert.

### Display examples

Trend display window (vertical flow)

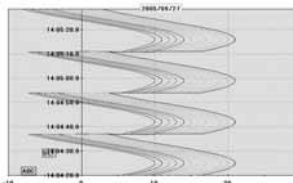

Trend display window (horizontal flow)

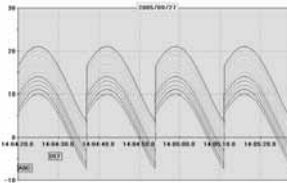

Bar-graph

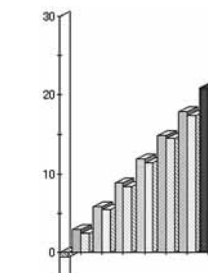

Trend display window (circular trend)

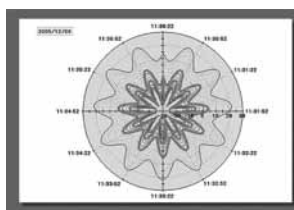

### Main functions

- Trend display  
Selectable from trend display window (vertical flow, horizontal flow) and circular trend display window.
- Continuous replay display window  
Trend is scrolled continuously (automatically).  
Scroll changes by speed and renewal data no.
- Data list display window  
Displays registered data as list display
- Bar-graph  
Displays by bar. Message can be inserted into bar-graph.
- Data between markers  
Displays date/time, time difference between 2 data, data difference, maximum, minimum, average, standard deviation and median among all data.
- Alarm display  
Points for alarm activation at each level are displayed on a trend graph.
- Settings  
Cursor, trend line, scale axis, time axis, title input on the graph, graph assistant and magnify/reduce/rotation of graphs
- Data conversion  
Exporting to Excel, and converting to CSV file or TEXT file are available.

### ENVIRONMENT

CPU	1GHz or faster
OS	Windows 98/Me Windows 2000/XP Home/XP Pro *Internet Explorer 4.0 or later
Memory	256MB or more (512MB or more recommended)
Disk drive	CD-ROM drive: 1 drive or more Hard disk drive: Disk space of 1 drive or more for 100MB or more
Language	Japanese, English, Chinese (simplified and traditional characters), Korean

**■ TERMINAL ARRANGEMENT**

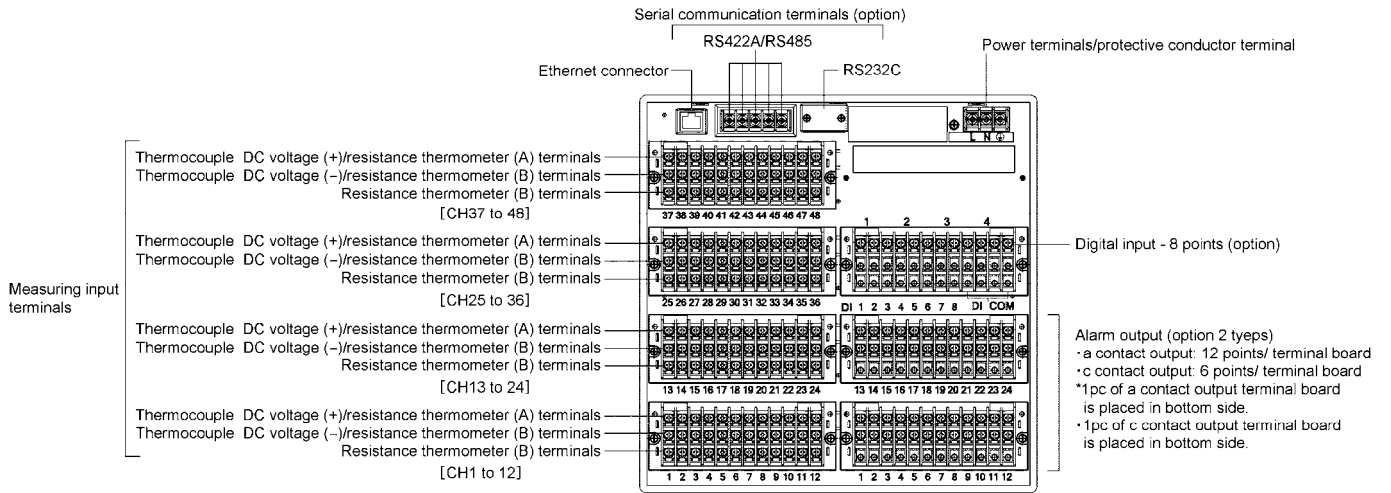

**Alarm/Digital input terminals**

● Alarm output (a contact output 12 points)

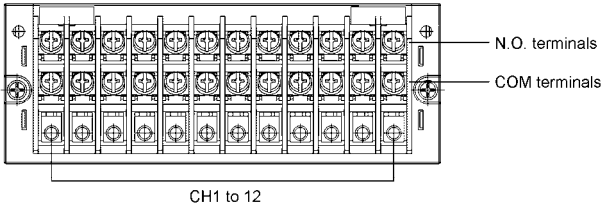

● Alarm output (c contact output 6 points)

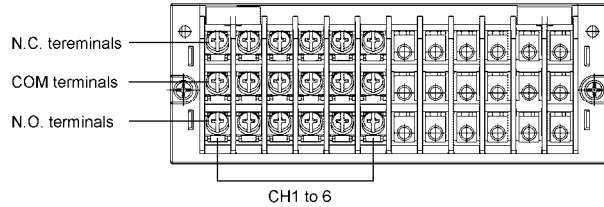

● Digital input

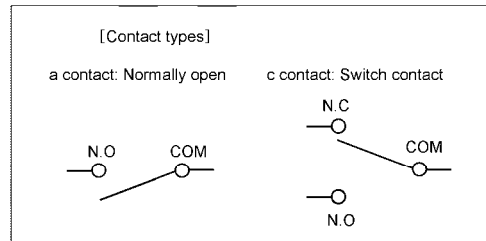
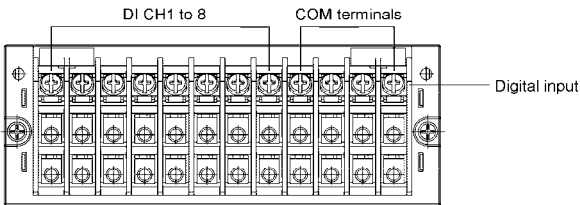

**■ DIMENSIONES**

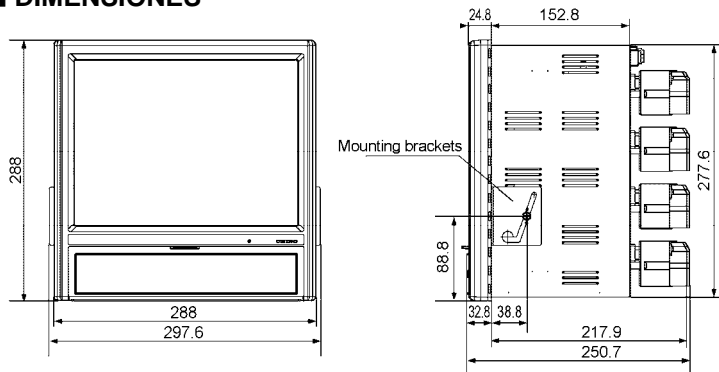

**■ Panel cutout and minimum clearance**

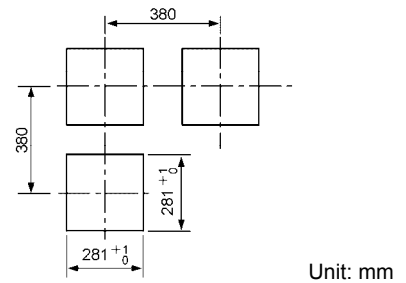

Specifications subject to change without notice. Printed in Japan (I) 2008. 1 Recycled Paper

**CHINO CORPORATION**

Degré 5 -13 chemin du Baudy - 69260 Charbonnières les Bains  
PHONE: 09 71 34 29 03  
FAX: 04 37 20 06 39  
E-mail: contact@degre5.com  
Website: http://www.degre5.com